

Carissimi Soci, il Roberto Burdese (IOBR), ci ha appena spedito il progetto di vibratore Solid State per impieghi generali. Ha un ingresso a 6/12/24 Vdc, e credo possa trovare molte applicazioni nel nostro campo. Credo sia per alcuni versi simile al nostro già presentato per impiego sull'RX AN/GRR-5.

Congratulazioni a Roberto che à recepito quello che "dovrebbe" essere l'Ham Spirit che ci distingue dai comuni "pigiabottoni" e dagli "ipnotizzati" dalle lucine!
Hi Hi.

Per info: r_burdese@virgilio.it

04/10

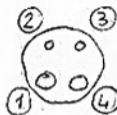
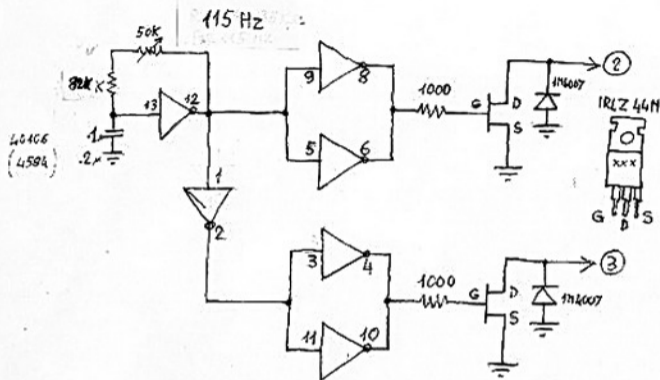

VIBRATORE
STATO SOLIDO

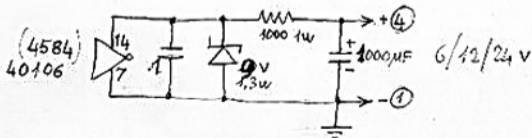

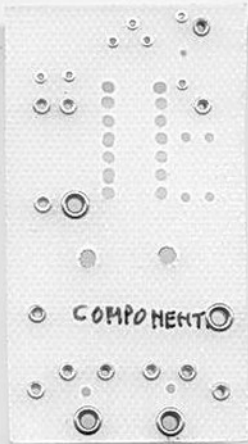
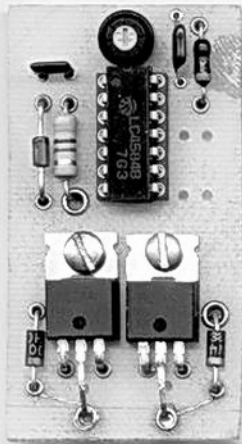

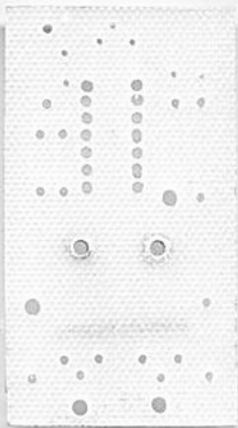
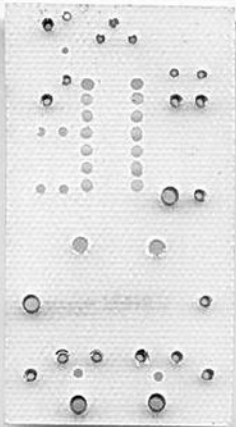
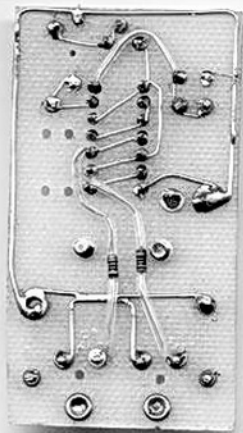

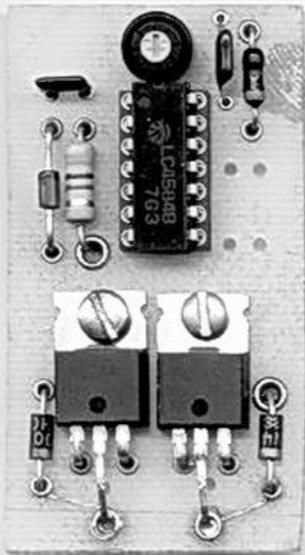

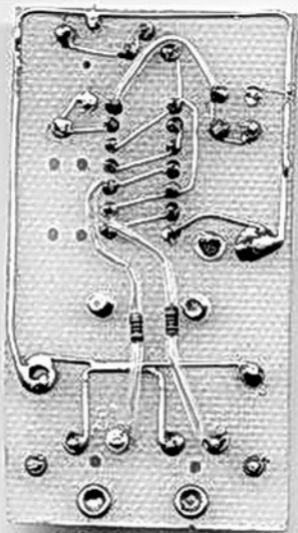

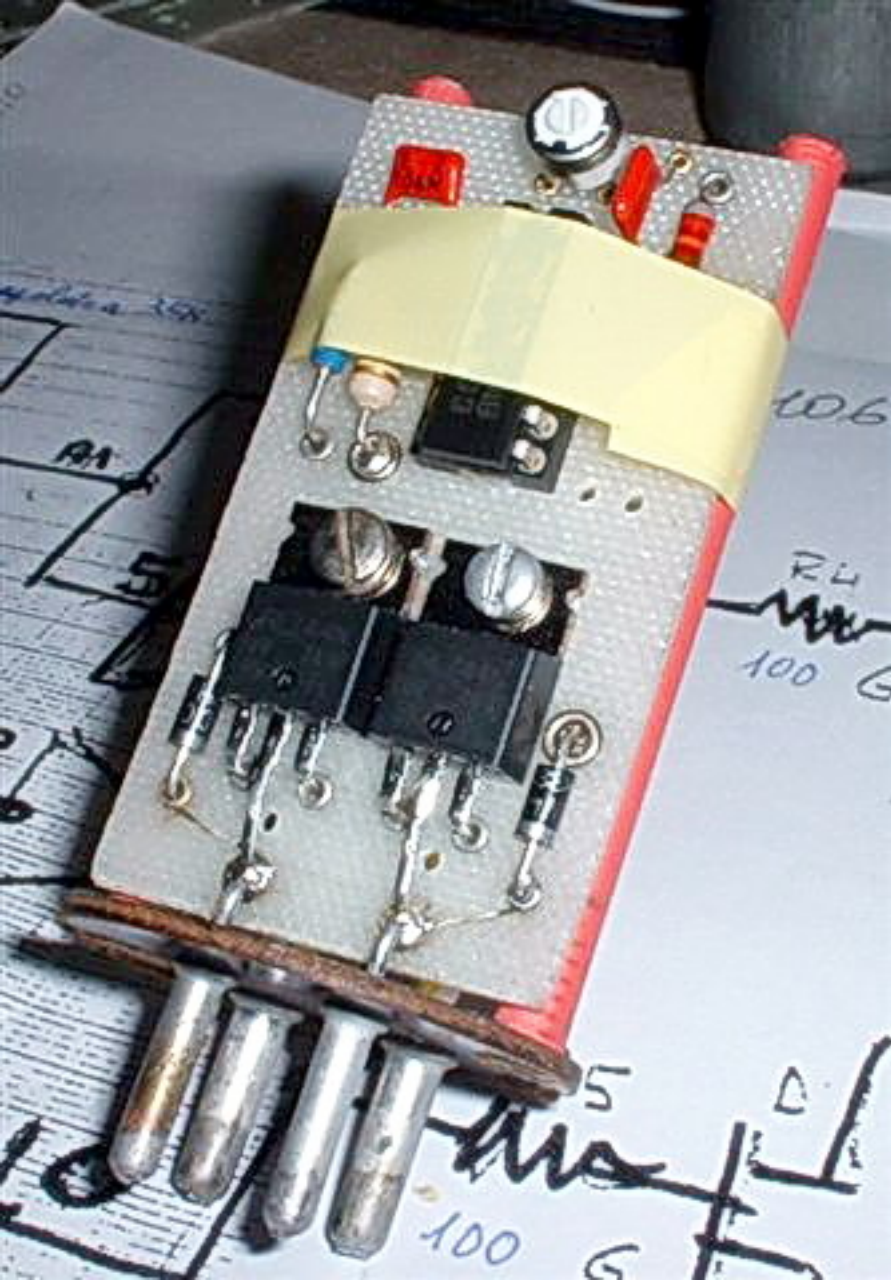

106

R_L
100 G

5
100 G